

HARWIN

INDESS

M20 and M22
(2.54mm and 2.00mm pitch)

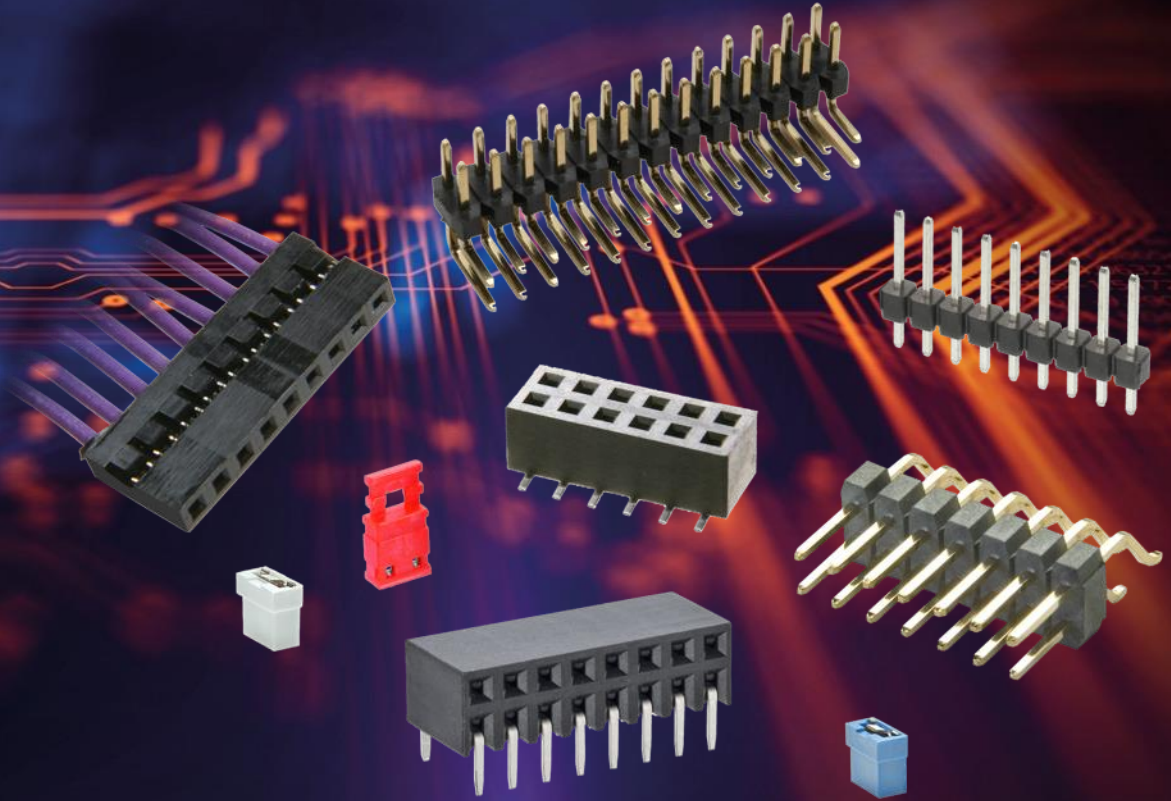

M20 AND M22 CONNECTORS - GREAT DESIGN FLEXIBILITY

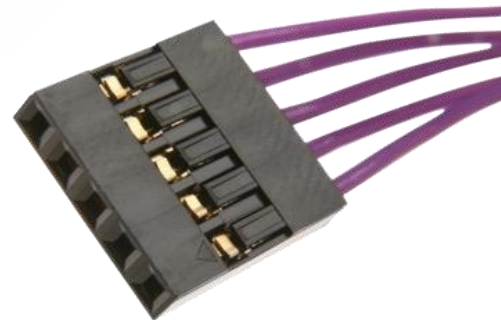
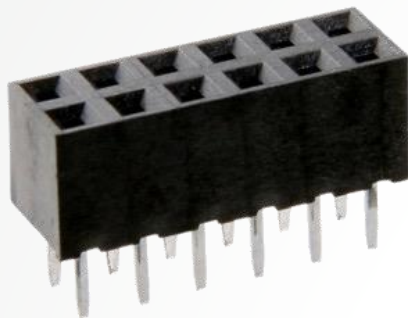

Today's electronics and PCB designers are faced with many connector challenges, including applications with increased PCB density, height restrictions and quality product – all whilst designing to a budget. The Industry Standard Pin Headers and Sockets from Harwin fulfil these requirements, and come in two common pitch sizes:

- [M20](#) – 2.54mm (0.1") pitch
- [M22](#) – 2.00mm (0.079") pitch

THE HEART OF THE CONNECTOR

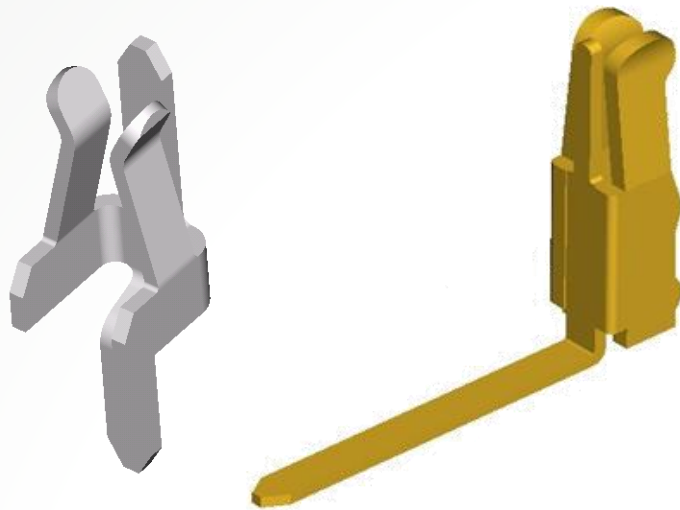

M20 and M22 sockets feature dual beam contacts, typically in phosphor bronze or other high-quality spring material. The dual beam connection gives good durability, repeatable retention and a reliable connection, offering a dependable, cost-effective connector. Design types include flat beam designs (as shown above) and tuning fork designs.

PCB MOUNT - SINGLE & DOUBLE ROW, SURFACE MOUNT & THROUGHBOARD

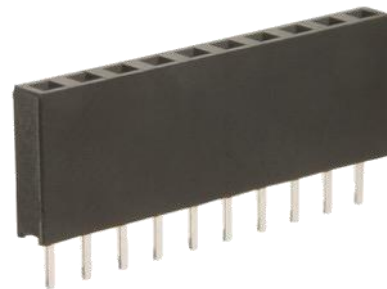
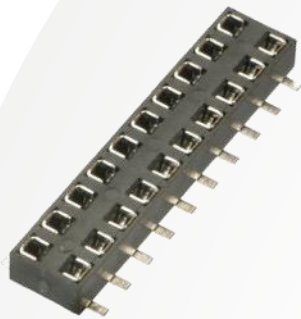
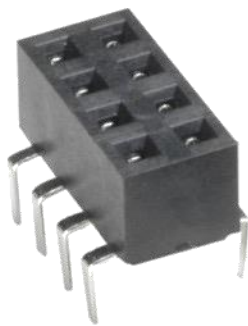

Female (Socket) connectors are available for PCB mounting in the following variations:

M20 (2.54mm pitch):

- Throughboard PC Tail for Vertical Top Entry, Dual Entry (Bottom Entry) and Horizontal
- Surface Mount for Vertical Top Entry, Dual Entry (Bottom Entry) and Horizontal

M22 (2.00mm pitch):

- Throughboard PC Tail for Vertical Top Entry
- Surface Mount for Vertical Top Entry, Dual Entry (Bottom Entry) and Horizontal

COMPLETE CABLE CONNECTOR SOLUTIONS

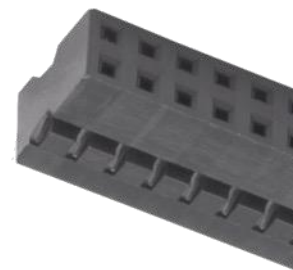
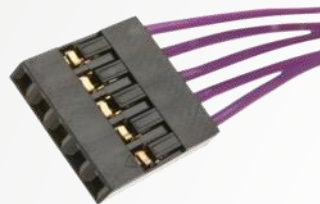

Both the M20 and M22 ranges offer a complete cable connector solution:

- Single and Double row crimp housings
- Loose and reeled crimp contacts
- Hand Crimp Tooling - [Z20-320](#) for loose M20 contacts, [Z22-020](#) for loose M22 contacts

PCB THROUGHBOARD - STANDARD CONNECTORS, MULTIPLE OPTIONS



The male connectors (commonly referred to as Pin Headers) with Throughboard Tails come with standard orientations of Vertical and Horizontal in both single and double row, and a variety of mating pin lengths.

- M20 – Mating pin lengths of 5.8mm, 6.1mm and 7mm;
- M22 – Mating pin lengths of 3.5mm and 4.2mm (recommended for mating with crimp connectors).

Housings are all made from high-temperature material suitable to withstand reflow soldering.

SURFACE MOUNT - TAPE AND REEL FOR AUTO-PLACEMENT

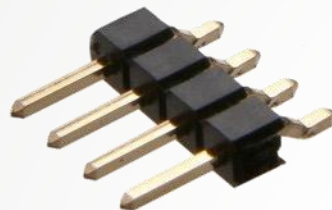

The Surface Mount Pin Headers come in both Vertical and Horizontal configurations. Each can be supplied in tape and reel packaging format to facilitate automated assembly processes to the PCB. Vertical SMT connectors in tape and reel will be fitted with disposable pick-and-place caps.

- M20 – 5.8mm mating pin length in Vertical Single/Double row, Horizontal Double row. 6mm for Horizontal Single row.
- M22 – 3.5mm or 4.2mm for Vertical Double row. 4mm for Horizontal Single row, 3.2mm or 4.2mm for Horizontal Double row.

JUMPER SOCKETS - PROGRAMMING CONNECTORS

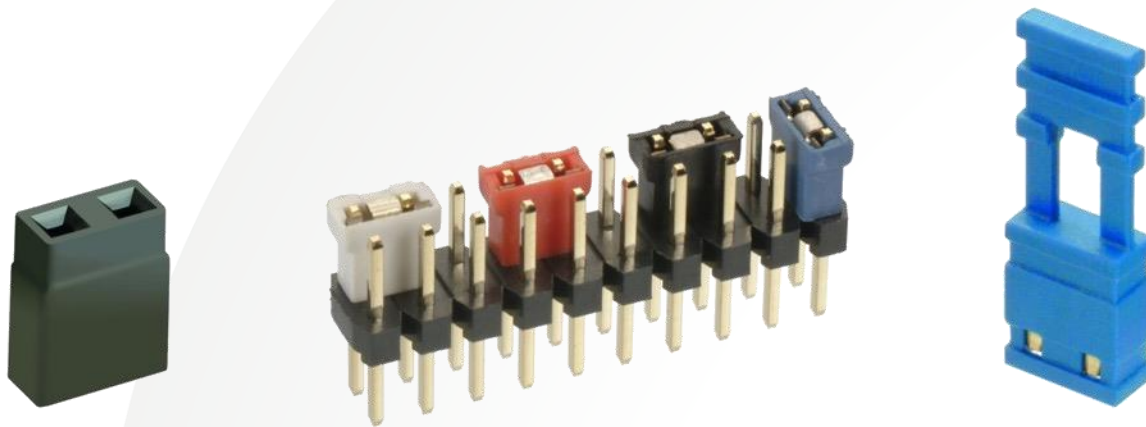

Jumper sockets (also known as shunts) provide additional programming options, changing data streams with manual placement of the sockets on a double-row pin header.

- [M20](#) (2.54mm) – Open top, closed top, short fixed handle, short and long flexible handle. The handles facilitate easy placement and removal of the sockets.
- [M22](#) (2.00mm) – Open top sockets only. The open top allows access to the internal contact for a test probe.

ELECTRICAL SPECIFICATIONS

| | |
|-----------------------|--|
| Current Rating | M20 = 3A per contact M22 = Up to 2A per contact |
| Contact Resistance | 20mΩ max |
| Insulation Resistance | 1,000MΩ min |

Component Specifications are given in more detail on individual connector Technical Drawings, located on each individual product page under Downloads.

MECHANICAL & ENVIRONMENTAL SPECIFICATIONS

| | |
|---------------------------|---|
| Durability | Up to 300 mating operations |
| Temperature Range | -40°C to +105°C (M22 Cable, Polarized = -25°C to +85°C) |
| Soldering Heat Resistance | 260°C for 10 seconds (M22 Polarized = 245°C for 5 seconds) |

All Throughboard M20 and M22 connectors are manufactured using the same housing materials used on the Surface Mount connectors, and can therefore withstand the same reflow soldering processes.

MARKETS



Many applications use 2.54mm and 2mm pitch connectors – these products are now very well established as standard connectors on embedded PCs, motherboards and larger electronics systems.

- Consumer Electronics
- Communications
- Drives and Controls
- Industrial Monitoring
- Personal Computing

Learn more about our other ranges



HIGH RELIABILITY
WITH SUPREME
PERFORMANCE



INNOVATIVE
DESIGNS FOR
EASY ASSEMBLY



DEPENDABLE
CONNECTIVITY
ACROSS THE BOARD

Find out more about our full range
of inter-connection solutions at

www.harwin.com

HRI
RANGE

EZI
RANGE

BBi
RANGE

Get Help from a Harwin Expert

Our experts are specialists in their field with many years of experience in their respective roles and industries.

Find an expert that can help you with your enquiry.

[Click Here >>](#)

CAD Models and Evaluation Samples also available at www.harwin.com



Contact Us

Europe, Middle East & Africa

T: +44 (0)23 9231 4545

E: technical@harwin.com

Americas

T: +1 603 893 5376

E: technical-us@harwin.com

Asia Pacific

T: +65 6 779 4909

E: technical-asia@harwin.com

WWW.HARWIN.COM