

Customer Information Sheet

DRAWING No: BH-001XXXX

SHEET 2 OF 2

IF IN DOUBT - ASK

©

NOT TO SCALE

THIRD ANGLE PROJECTION

ALL DIMENSIONS IN mm

BH-0011236

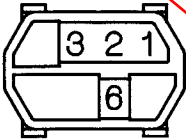

COLOUR:
NUT BROWN

MATING FEMALE CODING KEY:
BH-0024578

BH-0011567

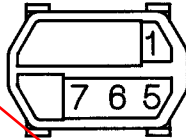

COLOUR:
BRILLIANT BLUE

MATING FEMALE CODING KEY:
BH-0022348

BH-0013467

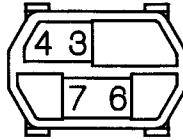

COLOUR:
SLATE GREY

MATING FEMALE CODING KEY:
BH-0021258

BH-0014678

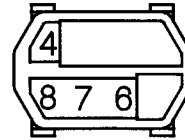

COLOUR:
OCHRE YELLOW

MATING FEMALE CODING KEY:
BH-0021235

OBSOLETE

BH-0011248

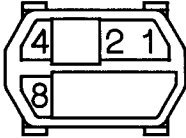

COLOUR:
STRAWBERRY RED

MATING FEMALE CODING KEY:
BH-0023567

BH-0012578

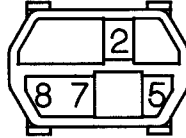

COLOUR:
RESEDA GREEN

MATING FEMALE CODING KEY:
BH-0021346

BH-0013478

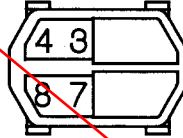

COLOUR:
STEEL BLUE

MATING FEMALE CODING KEY:
BH-0021256

BH-0011356

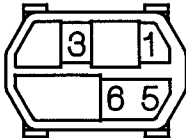

COLOUR:
LILAC BLUE

MATING FEMALE CODING KEY:
BH-0022478

BH-0013456

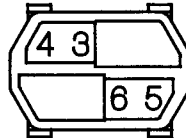

COLOUR:
CADMIUM YELLOW

MATING FEMALE CODING KEY:
BH-0021278

BH-0013568

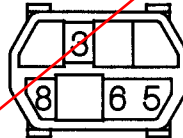

COLOUR:
PASTEL ORANGE

MATING FEMALE CODING KEY:
BH-0021247

BH-0011368

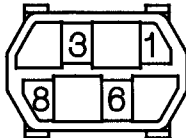

COLOUR:
YELLOW GREEN

MATING FEMALE CODING KEY:
BH-0022457

SECTION X-X

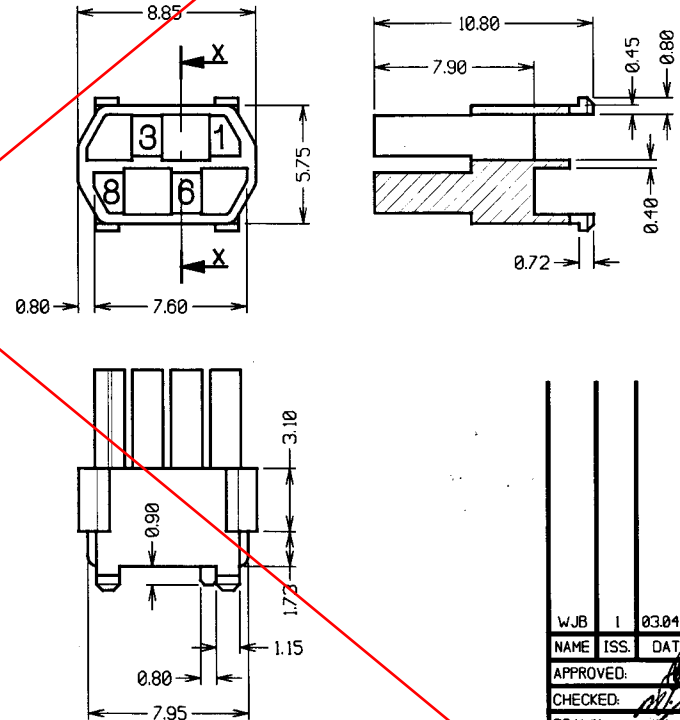

- NOTES:
- FOR USE WITH TYPE A HARD METRIC CONNECTORS (BH-54XXX22 AND BH-55XXX22 SERIES), AND TYPE A SHROUDS (BF-030XX00 SERIES).
 - EQUIVALENT FEMALE CODING KEYS ARE DETAILED ABOVE.
 - FOR COMPLETE SPECIFICATION, SEE COMPONENT SPECIFICATION C038XX (LATEST ISSUE).

WJB	1	03.04.02	----
NAME	ISS.	DATE	C/NOTE
APPROVED: <i>[Signature]</i>			
CHECKED: <i>[Signature]</i>			
DRAWN: W. J. BOURNE			
CUSTOMER REF.:			
ASSEMBLY DRG:			

HARWIN

HARWIN INC
U.S.A.
TEL: (812) 285 0055
FAX: (812) 285 0056

HARWIN PLC
U.K.
TEL: 023 9237 0451
FAX: 023 9231 4590

HARWIN PTE
SINGAPORE
TEL: 65 7794909
FAX: 65 7793868

THIS DRAWING AND ANY INFORMATION OR DESCRIPTIVE MATTER SET OUT HEREON ARE CONFIDENTIAL AND COPYRIGHT PROPERTY OF THE HARWIN GROUP AND MUST NOT BE DISCLOSED, LOANED, COPIED OR USED FOR MANUFACTURING, TENDERING OR FOR ANY OTHER PURPOSE WITHOUT THEIR WRITTEN PERMISSION.

TOLERANCES
X. = ±1mm
X.X = ±0.25mm
X.XX = ±0.10mm
X.XXX = ±0.01mm
ANGLES = ±5°
UNLESS STATED

MATERIAL:
15% GLASS-FILLED PBT,
UL94V-0
FINISH: CLEAN
S/AREA: mm²

TITLE: HARD METRIC MALE CONNECTOR CODING KEY FOR TYPE A
DRAWING NUMBER: BH-001XXXX
SHT 2 OF 2